

FENCING CYCLONIC SELECTION & INSTALLATION GUIDE

REGION C - TERRAIN CATEGORY 2, 2.5 & 3
REGION D - TERRAIN CATEGORY 2



A Met-TECH™ GUIDE

DECEMBER 2018

Colorbond®



Metroll®

BETTER SERVICE • BETTER BUILDING SOLUTIONS

CYCLONIC REGION FENCE INSTALLATION

This guide provides instructions for the selection and installation of Metroll fencing in Cyclonic Region C - Terrain Category 2, 2.5 & 3 and Cyclonic Region D - Terrain Category 2. For Regions A & B please refer to the Metroll Non-cyclonic Selection & Installation Guide.

HOW TO USE THIS GUIDE

STEP 1: PLAN YOUR FENCE Read this step to identify your Wind Region. Your Wind Region determines the design criteria for your fence.

STEP 2: Go to the relevant section based on your Wind Region, i.e REGION C Fence Selection or REGION D Fence Selection.

STEP 3: INSTALLING YOUR REGION C OR REGION D FENCE Once you know the requirements for your fence this section details its installation.



STEP 1: PLAN YOUR FENCE





Understand Wind Regions and Terrain Categories which determine your fence set-up requirements.

Metroll fencing is designed to withstand most wind conditions. The wind load on your fence at your site will depend on a number of factors, including where you live, where the fence is to be installed and the number of surrounding properties.

Identifying your Wind Region and Terrain Category will help you choose the right fence designed to perform best in your location.



1. IDENTIFY YOUR WIND REGION

	REGION A 41m/s or 147.6kmph	Refer to the Metroll Non-cyclonic Installation Guide for these Regions
	REGION B 51.9m/s or 186.8kmph	
	REGION C 64.5m/s or 232.2kmph	
	REGION D 88m/s or 316.8kmph	

2. IDENTIFY YOUR TERRAIN CATEGORY

Category 2 Open terrain, including grassland with well scattered obstructions having heights of typically 1.5 - 5m with no more than 2 obstructions per hectare.

Category 2.5 Terrain with a few trees or isolated obstructions. Example: Terrain in developing outer urban areas with scattered houses.

Category 3 Terrain with numerous closely spaced obstructions with heights typically between 3 - 10m. Example: Suburban housing.

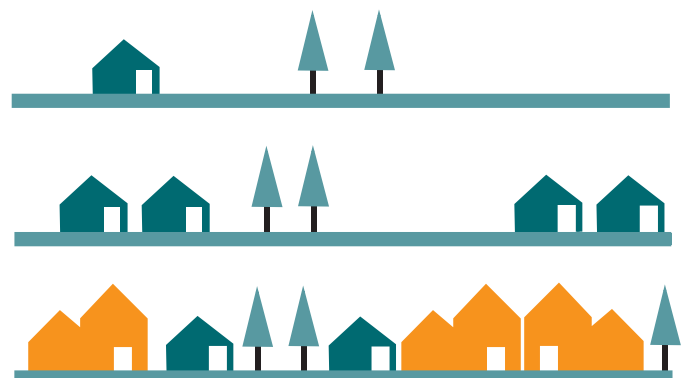

REGION C FENCE SELECTION

REGION C DESIGN CRITERIA

1. Panels must not exceed 1800mm from ground level.
2. Where SHS Posts are required, SHS Post to be a minimum of C350.
3. Where SHS Posts are required end caps must be fitted.
4. Posts & Rails to be 0.8mm BMT G550 steel, minimum Z275 coating.
5. Infill Panels to be 0.35mm BMT G550 steel, minimum AZ150 coating.
6. All fasteners to have minimum Class 4 corrosion resistance.
7. Post footings to have 250 diameter with depth as per Footing Depth Table - See page 4.
8. Install fence caps to all posts. Fix fence caps to manufacturers specifications.
9. Top soil is excluded from footing depth.
10. Concrete for footings to be a minimum N20 grade with top of footing shaped to direct water away.

11. Overlap sheets to suppliers specifications.
12. Wind loads in accordance with AS1170.2:2011 - Wind Loads. Wind Region C - Terrain Categories 2, 2.5, 3

VR 61m/s

Fc 1.05

Annual Probability of Exceedance 1:200

WIND LOAD ASSUMPTIONS	TERRAIN CATEGORY		
	2	2.5	3
Terrain Multiplier (Mz, cat) Up to 1800mm	0.91	0.87	0.83
Shielding Multiplier (Ms)	0.95	0.90	0.80

Md 1.0 Wind Directional Multiplier

Mt 1.0 Topographic Multiplier

Cpn 1.2 Except Tapered Ends

Refer to AS/NZS 1170.2 for varied shielding conditions.

1. CHOOSE YOUR REGION C FENCE STYLE & COMPONENTS

FENCE COMPONENTS

- Posts
- Rails
- Infill Sheets
- Post Caps
- SHS Posts
- Fasteners



TRIMCLAD®
ALL STATES



METLINE® QLD, TAS
HARMONY® WA



METROSPAN®
QLD

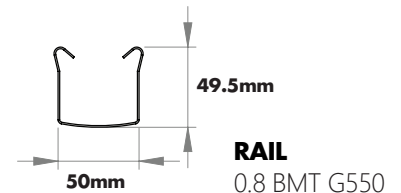
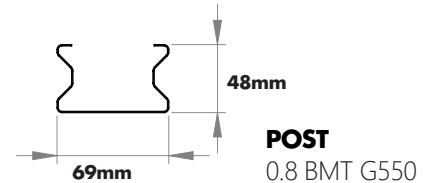

2. CHOOSE YOUR REGION C FENCE PANEL SET-UP

Fence panels can be 2 or 3 sheets wide. The installation requirements differ depending on which set up you choose.

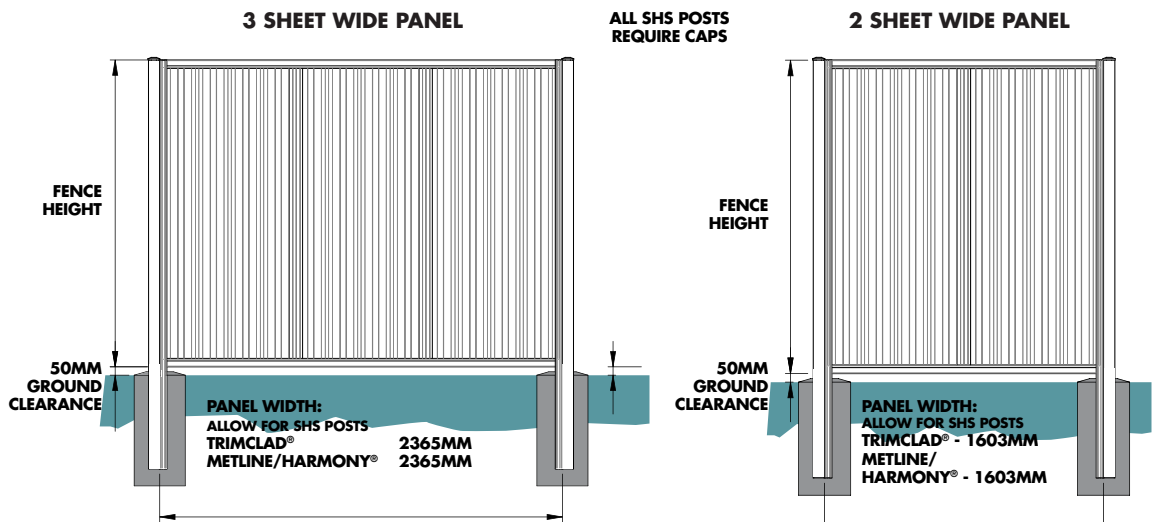

3. DETERMINE YOUR REGION C POST SET-UP



PANEL HEIGHT (MM)	TERRAIN CATEGORY		
	2	2.5	3
3 SHEET WIDE PANEL			
1500	50 x 2 or 65 x 1.6 SHS + STD	50 x 2 or 65 x 1.6 SHS + STD	50 x 1.6 SHS + STD
1800	65 x 3 or 89 x 2 SHS + STD	65 x 3 SHS + STD	65 x 2 SHS + STD
2 SHEET WIDE PANEL			
1500	STD	STD	STD
1800	50 x 2 or 65 x 1.6 SHS + STD	50 x 2 or 65 x 1.6 SHS + STD	50 x 1.6 SHS + STD

4. DETERMINE YOUR REGION C FOOTING DEPTH

SOFT SOIL > 100kPa

PANEL HEIGHT (MM)	TERRAIN CATEGORY		
	2	2.5	3
3 SHEET WIDE PANEL			
1500	1100mm	900mm	700mm
1800	1100mm	900mm	700mm
2 SHEET WIDE PANEL			
1500	900mm	700mm	500mm
1800	900mm	700mm	500mm

MEDIUM / STIFF SOIL > 200kPa

PANEL HEIGHT (MM)	TERRAIN CATEGORY		
	2	2.5	3
3 SHEET WIDE PANEL			
1500	700mm	600mm	500mm
1800	700mm </td <td>600mm</td> <td>500mm</td>	600mm	500mm
2 SHEET WIDE PANEL			
1500	500mm	500mm	500mm
1800	500mm	500mm	500mm

POST SET-UP DETAIL

STD - STANDARD POST TO POST

SHS POST TO SHS

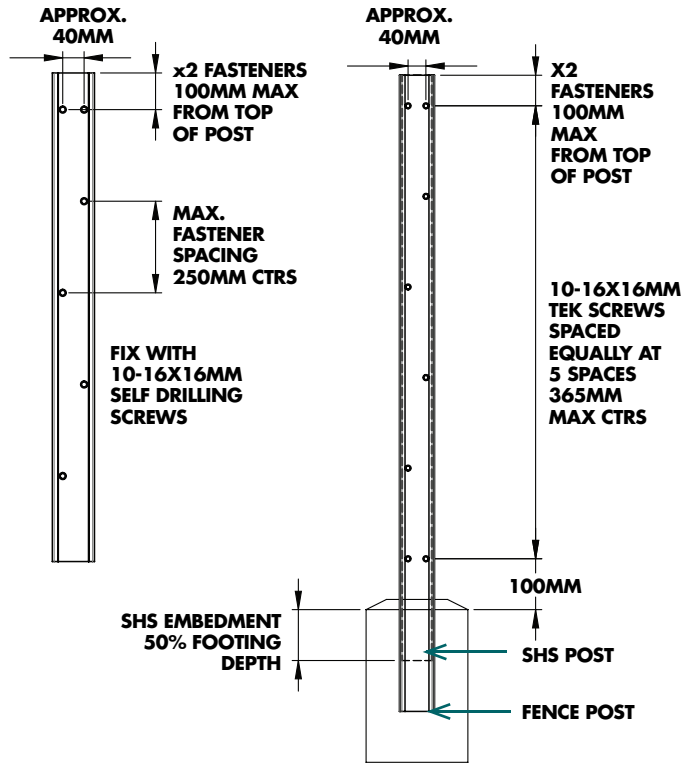

FOOTING DETAIL

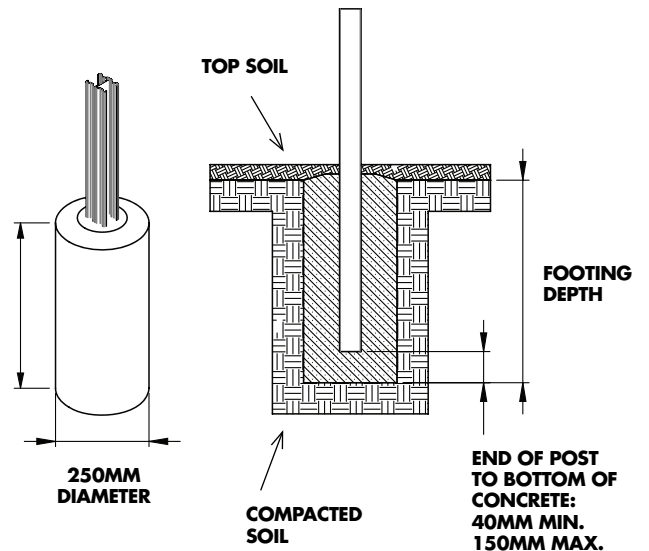

REGION D FENCE SELECTION (WA)

REGION D DESIGN CRITERIA

1. Panels must not exceed 1800mm from ground level.
2. Panels require stiffening with the addition of a 75 x 75 x 3.0mm G450 SHS post between each panel and at the last panel (see Detail 1 page 8).
3. Footings to be minimum 300 x 800mm deep in N20 concrete.
4. Sheeting must be fixed to top and bottom rails in every pan with 14 x 25 tek screws.
5. All fasteners to conform to AS 3566 Class 3.
6. Wind loads in accordance with AS1170.2:2011 - Wind Loads. Region D - Terrain Category 2 - Importance Level 1

V50 Ultimate 66m/s

Mz 0.91

Ms 1.0 Unshielded - Open land/edges of towns
0.7 Shielded - Towns

Mt 1

Cp (max) 1.8 at ends and corners
1.28 at all other locations

7. The foundation material is to have a dry density ratio of 95% when tested in accordance with AS1289 cl 5.1.1 and cl 5.4.1. Local practice in some areas for well-known materials may rely on acceptance criteria based on other parameters, such as penetrometers as described in AS1289 cl 6.3.2 and cl 6.3.3, however, a correlation between dry density ratio and penetrometer resistance will be required for each material type.
8. Post footings to be $\varnothing 300$ with depth as per Table 1. Concrete to conform with AS3600 - Concrete Structures Code. Concrete to be N20/20/100.
9. All steelwork in accordance with AS4100 - Steel Structures and AS4600- Cold Formed Steel Structures.
10. All welding to be in accordance with AS1554 - Pt 1 - Welding of Steel Structures.
11. Post and rail spacings to be as per Table 1.
12. All fence posts to be as per Table 1 and to be fixed either side of SHS post. See Detail 1 page 8. Post to be fixed with 14 x 22 tek screws at max. 200cc spacings. Ensure two screws are located max. 60mm from top and bottom.

13. All rails to be Metroll rails.
14. Rails to be fixed to posts with 14 x 22 tek screws on both sides of post.
15. Install fence caps to all posts. Fix fence caps to manufacturers specifications.
16. Prepare site such that water cannot pond over post footing pads.
17. All surface treatments to be suitable for the site exposure classification and in accordance with the protective coatings requirements of Table 3.4.4.2 of the BCA, Volume 2.
18. Sheeting to be Metroll Trimclad 0.48mm BMT (or equivalent). Fix sheeting to rails using 14 - 10 x 25 tek screws. Locate a tek screw in every pan adjacent to rib.
19. Overlap sheets to suppliers specifications.

TABLE 1: REGION D INSTALLATION REQUIREMENTS

SHIELDING TYPE Ms	FENCE HEIGHT (H)	SHS POST REQUIREMENT (MM)	INTERMEDIATE & END PANELS	
			COLUMN SPACING	POST FOOTING DEPTH
0.7	1800mm max.	75 x 75 x 3.0	1655mm	800mm
1			1665mm	800mm

REGION D FENCE LAYOUT

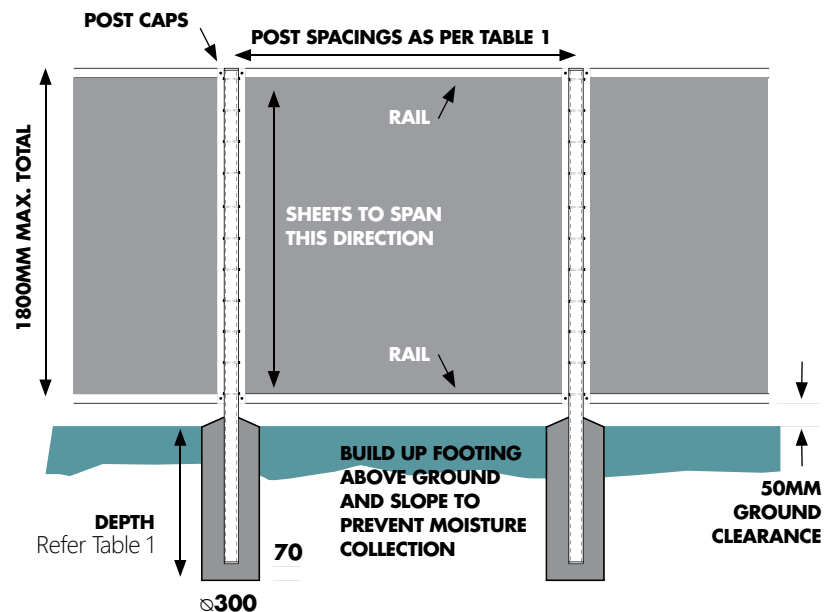

1. CHOOSE YOUR REGION D FENCE STYLE & COMPONENTS



TRIMCLAD®



Domain®



Paperbark®

Available in Domain® & Paperbark®

Other colours available subject to minimum order quantities and lead times.

COMPONENTS OF 1x1750x1590 CYCLONIC PANEL

- 2x 2700mm Posts
- 2x 1590mm Rails
- 2x Trimclad® 0.48 BMT 1740mm sheets
- 1x 75 x 75 x 3.0mm G450 2660mm SHS Post (Ms 1 zone)
- 34x 14 x 22 Tek screws
- 16x 14 x 25 Tek screws
- 1x Post Cap

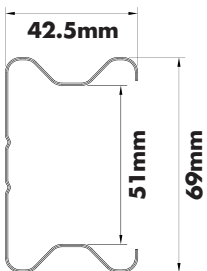

POST
0.8 BMT G550

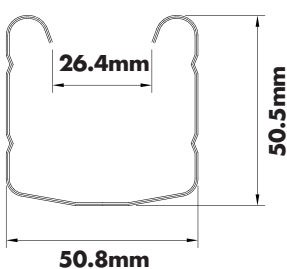

RAIL
0.8 BMT G550

STEP 3: INSTALLING YOUR REGION C OR REGION D FENCE

BEFORE YOU BEGIN

- Check for underground services before you dig.
- Check council regulations on boundary fencing.
- Identify the soil type to determine the concrete required for the job.
- Read this guide completely to ensure you understand the process. Pay particular attention to items marked IMPORTANT as they will ensure the satisfactory long term performance of your fence.

INSTALLATION TYPES

If the ground is not level where your fence is being installed you will need to consider if the fence will be stepped or raked. You will also need to taper the end of your fence over the last two panels where there is no corner. (See page 8).

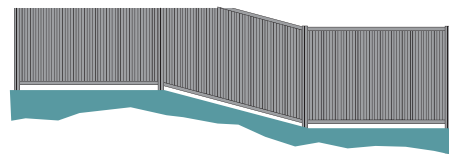

RAKED

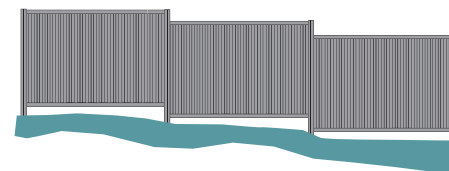

STEPPED

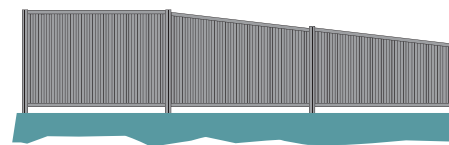

TAPERED

1. REQUIRED EQUIPMENT

- Self-drilling Screw Gun/Drill
- Spirit Level
- Tin Snips or Nibbler
- Rubber Mallet
- String Line & Marker Pegs
- Shovel / Spade
- Marker (NOT lead pencil)
- Concrete
- Hacksaw
- Rivet Gun
- Post Hole Digger
- Tape Measure
- Safety Glasses & Gloves

2. MARK OUT THE POST HOLES

Run a string line the length of the fence and dig the first hole.

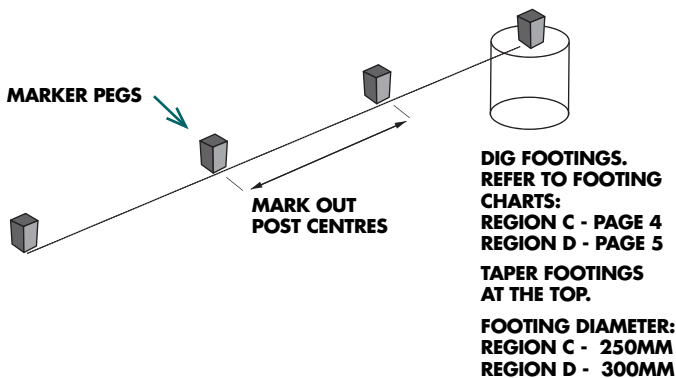

3. ASSEMBLE POSTS

Assemble the required posts based on your region and post configuration:

REGION C: Refer to Post Set-Up Detail on page 4.

STANDARD POSTS: Fix back to back with 10-16x16mm fasteners at 250mm centres and double at the top.

FENCE POST TO SHS POST: Fix with 10-16x16mm fasteners at 365mm centres and double at the top and bottom.

REGION D: All posts are to be stiffened with the addition of an SHS post (Refer Table 1: Installation Requirements, page 5). Posts are fixed with 14 x 22mm hex head self-drilling tek screws at each side at top, bottom and 200mm centres in between.

POST FOOTINGS

Premixed concrete may be used (20 MPa min.) Mix your concrete as per manufacturers instructions or use the following as a guide:

4 parts 20mm aggregate : 2 parts sand : 1 part cement

POSTS IN LIMESTONE WALLS

Metroll recommend consultation by an engineer for installation into limestone walls.

Limestone walls must be of sufficient strength to withstand wind loading. This strength is dependent on the quality and strength of the limestone blocks and of the mortar bonds.

4. INSTALL POSTS

PREPARE THE FIRST POST

1. Take a single post measure down the height of your fence and mark - this is the bottom rail position.
2. Place in footing and adjust to correct height. Ensure the footing is as follows:
REGION C: Minimum 40mm and maximum 150mm deeper than the end of the post.
REGION D: Minimum 70mm deeper than the end of the post.
3. Concrete the post in making sure the bottom rail mark is no more than 50mm above the ground.
4. Pack the concrete hard against the post and use a level to ensure the post is vertical. Ensure the top of the concrete tapers away from the post to allow for drainage.
5. Clean off any concrete splashes and allow to set .

PLACE REMAINING POSTS

1. While the first post is setting lay a string line, mark out and dig the remaining holes. Use the bottom rail as a guide. Remember raked fences may require longer rails.
REGION D: Dig the remaining holes at 1665mm centres for Ms 1 or 1655mm centres for Ms 0.7.
2. Position gate posts if required.
3. Place the second post into the hole and insert a bottom rail between the posts using the marks to position. Ensure the rail is inserted fully into the posts and that there is a gap of 50mm between the bottom rail and the ground. Placing a packer under the rail can assist while the rail is then screwed into position.
4. Place the top rail into the posts and fix with self-drilling screws on both sides of the post as follows:
REGION C: Use 12 x 20mm self-drilling screws
REGION D: Use 14 x 22mm self-drilling screws
Do not fully tighten as these screws must be removed to insert the sheets. Use a level to position posts in line and at the correct height. Concrete in the second post.
5. Continue to install the framework until completed. Do not install the infill sheets at this time.



TAPERING THE FENCE AT FREE ENDS

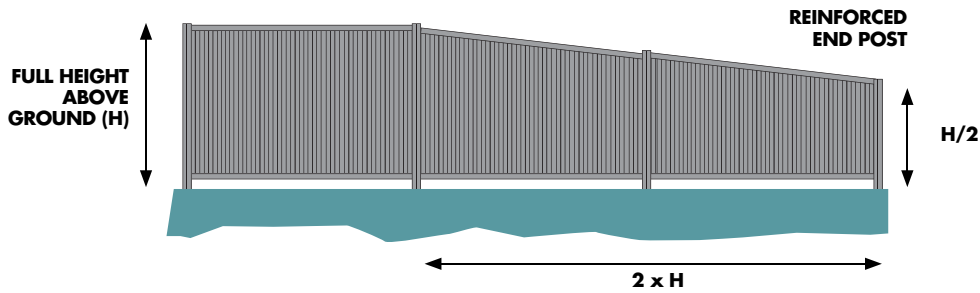

At the end of a fence run where the fence does not form a corner (called a free end), step down the last panels so that the height of the end panel is half the height of the full fence height.

Tapering applies to twice the fence height from free ends.

EXAMPLE: For a 1.8m high fence, the end spacings will apply for $2 \times 1.8 = 3.6\text{m}$ from any free end or corner.

REGION C END POST OPTIONS

Where ends are not tapered, end posts must be incorporated as follows:

PANEL WIDTH	PANEL HEIGHT (MM)	TERRAIN CATEGORY		
		2	2.5	3
3 Sheets	1500	65 x 4 SHS + STD	65 x 3 SHS + STD	50 x 5 SHS + STD
	1800	89 x 3.5 SHS + STD	65 x 6 SHS + STD	65 x 5 SHS + STD
2 Sheets	1500	50 x 3 SHS + STD	50 x 2.5 SHS + STD	50 x 2 SHS + STD
	1800	65 x 4 SHS + STD	65 x 3 SHS + STD	50 x 5 SHS + STD

5. DETERMINE ENDS, CORNERS & JUNCTIONS

The types of ends, corners and junctions of your fence will depend on your post set-up, i.e standard post to post or post to SHS post configuration.

POST CONNECTION DETAILS

REGION C - Refer Page 5

STD - STANDARD POST TO POST



END POSTS

SHS POST TO SHS

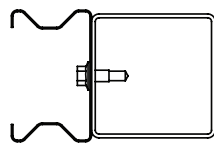

INTERNAL POSTS

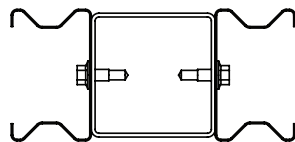
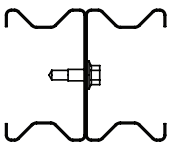

CORNER POSTS

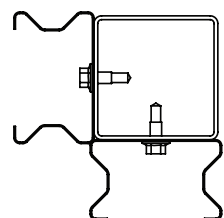
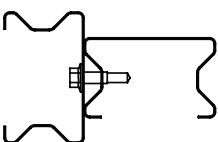

REGION D - DETAIL 1: SHS COLUMN & POSTS

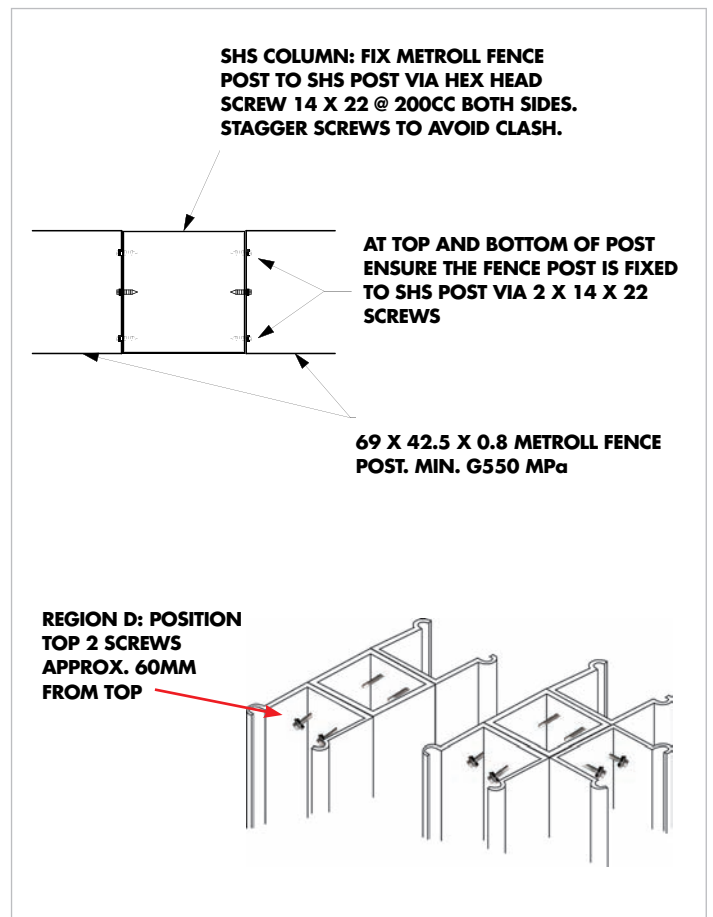

6. INSTALL INFILL SHEETS

1. Allow the concrete footings to set for a minimum of 24 hours.
2. Remove the screws on one side of the top rail and hinge it up to slide the infill sheets into the bottom rail. Lower the top rail over the sheets to help hold the sheets together.

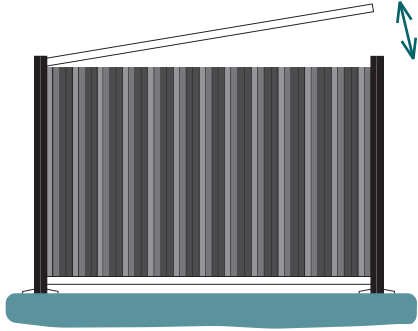

3. Allow for an overlap when inserting infill sheets.

METLINE® / HARMONY® OVERLAP



TRIMCLAD® OVERLAP



4. Once all sheets are in place step back and assess the panel. Make adjustments where required to ensure rails are aligned and the overall panel looks right.
5. Screw the top rail in place once satisfied. Then fix each infill sheet to rails as follows:

REGION C:

10 x 25mm self drilling screws as follows:

TRIMCLAD®	Every crest
METLINE®/HARMONY®	Every crest
METROSPAN®	Every 2nd crest

Fix all infill sheets at mid span using 3mm rivets.

REGION D:

14 x 25mm tek screws in each Trimclad® pan at top and bottom rail.

6. Fix post caps using hex head screws.
7. Rinse the fence clean of swarf.

UNEVEN SITES & VERTICAL SLITTING

If a slope is greater than 1:8 this may reduce the sheet coverage to a point where one of the sheets may require vertical slitting. On Colorbond® and Zinalume® sheets this can be achieved using a straight edge and scoring with tungsten tipped hand cutters, then bending and snapping the sheet.

HOW TO DETERMINE THE CUT OF INFILL SHEETS

1. Place a spirit level inside the rail at the high end.
2. Measure across the width of a sheet. From this point measure the height from the bottom of the level to the inside of the rail. This determines the angle of the cut.
3. Where possible match the angle of the top of the rail to that of the bottom rail. The top rail angle can be adjusted if desired, but note that the post height will increase. Make allowances for this when fixing posts in the ground.
4. Measure the height of the cut required from the base of the infill sheet. Do the same at the top of the sheet to ensure angles match. Ensure you measure from edge to edge of the infill sheet. Placing all infill sheets together and cutting once will ensure uniformity.

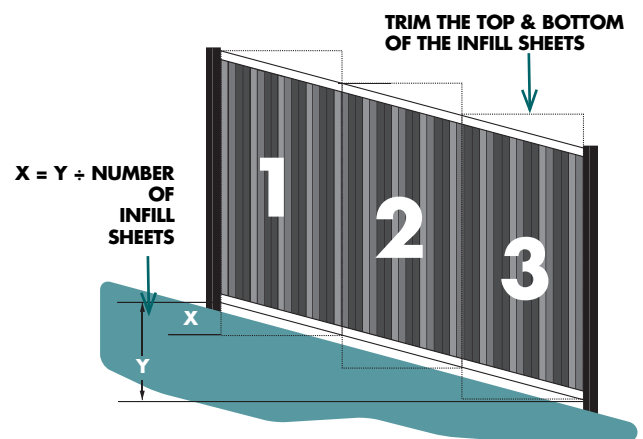

FENCE MAINTENANCE & WARRANTY

To keep your fence looking its best, simply hose it down periodically with water. A soft broom can be used to remove cobwebs. Pay particular attention to the area under the top rail which is sheltered from natural washing by rain.

IMPORTANT

- Don't allow soil, garden fill or dirt to build up against the bottom rails and posts of your fence as this will retain water and lead to corrosion. Adequate drainage is needed to ensure that water does not pond in the bottom rail. Drainage holes exist for this purpose.
- Don't use your fence as a retaining wall as it is not designed for this purpose.
- Don't spray the fence with garden sprays or fertilisers as this will damage your fence. Wash the fence immediately with water should this occur.
- Don't use touch up paint on your fence. Minor scratches should be left alone. Alternatively the infill sheet can be replaced. Touch up paint weathers differently to COLORBOND® steel and will **void** the 10 Year BlueScope Steel Material Warranty.
- Don't allow your fence to come into contact with bare steel, lead, copper, chemically treated or green timber as these are not compatible with COLORBOND® steel.

THE COLORBOND® STEEL WARRANTY

ELIGIBILITY

Availability and duration of warranties depend upon a number of factors, including location and how products are installed. The online warranty system considers the specifics of your product and will determine if you are eligible for a warranty and for how long.

WHAT DOES THE WARRANTY COVER?

Depending on eligibility and product application, BlueScope Steel offers a Fencing Warranty of up to 10 years from the date of installation against corrosion to perforation by weathering in the natural elements. BlueScope Steel also warrants that the paint system will not flake or peel due to natural weathering for up to 10 years. Your official BlueScope Steel Warranty Certificate will advise what your warranty covers and for how long.

APPLY ONLINE

BlueScope Steel is committed to quality service and support. By applying online you will ensure your warranty is permanently on record. That's peace of mind you can count on.

How to apply for your warranty certificate

1. Go to www.bluescopesteel.com.au/warranties
2. Sign up and register your details.
3. Follow the prompts to complete your registration.

QLD		NSW		VIC		TAS	
Cairns	07 4054 0888	Lismore	02 6622 6677	Preston	03 9480 3744	Launceston	03 6335 8555
Townsville	07 4779 8266	Tamworth	02 6765 4799	Laverton	03 8369 8300	NT	
Mackay	07 4968 1255	Newcastle	02 4954 5799	Geelong	03 5248 2006	Darwin	08 8935 9555
Rockhampton	07 4920 0900	Sydney	1300 766 346	Ballarat	03 5335 6416	WA	
Bundaberg	07 4155 5999	Dubbo	02 6883 4800	Pakenham	03 8710 9300	Perth	08 9365 5444
Toowoomba	07 4634 6144	Wagga Wagga	02 5924 4500	SA		Bunbury	08 9796 9796
Sunshine Coast	07 5493 7872	ACT		Adelaide	08 8282 3300	Albany	08 9841 6966
Brisbane	07 3375 0100	Canberra	02 6298 2777				

26 Metroll Branches Nationwide

Colour swatches and images have been reproduced as accurately as possible. Metroll recommend always checking your chosen colour against an actual product sample before purchasing.

COLORBOND®, BlueScope and the BlueScope Steel brand are all registered trademarks of BlueScope Steel Limited.

All reasonable care has been taken in the compilation of the information contained in this brochure. All recommendations on the use of our products are made without guarantee as conditions of use are beyond the control of Metroll. It is the customers responsibility to ensure that the product is fit for its intended purpose and that the actual conditions of use are suitable. Metroll pursues a policy of continuous development and reserves the right to amend specifications without prior notice.

The Metroll M and Logo are registered trademarks of Metroll Pty Ltd. Metroll Pty Ltd. ABN 97 001 446 439.

FIC_CD_DEC18



metroll.com.au