

SafeBridge



# SAFEBRIDGE<sup>®</sup>

## HIGH PERFORMANCE ROOF INSULATION SYSTEM



## Safebridge® Key Benefits

- Creates a safer roof environment for workers during construction
- Code compliant with BCA/NCC Section J
- Uses the purlin space without elevating the overall roof or fascia height
- Suitable for cyclonic and non-cyclonic regions

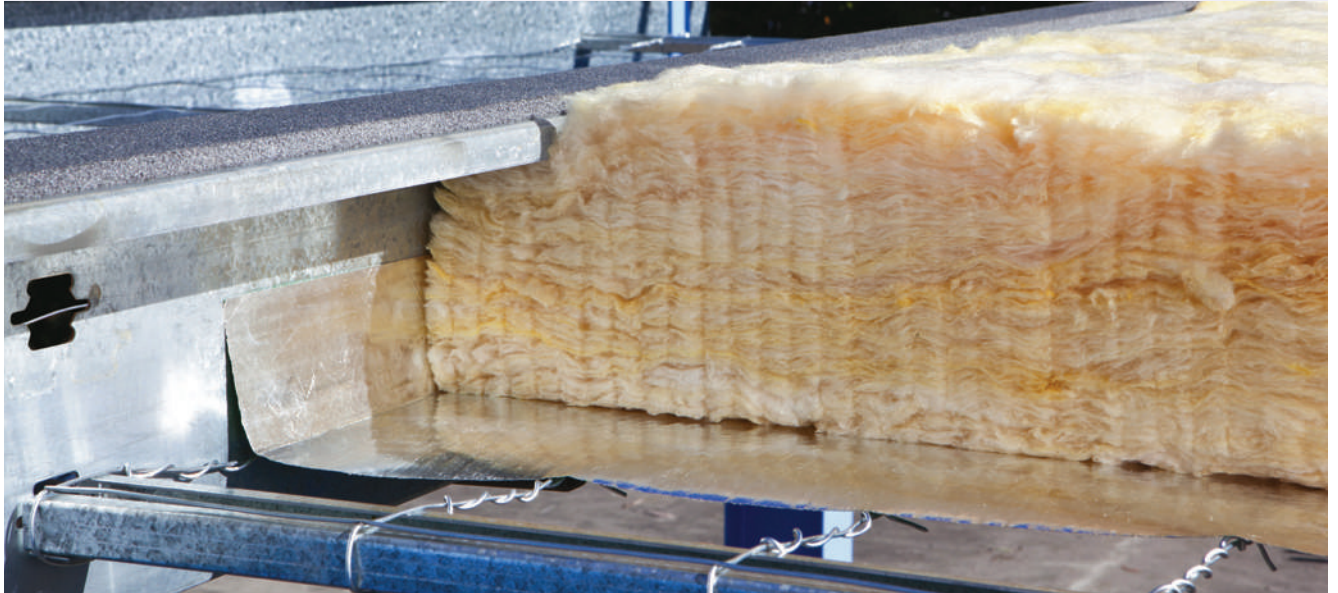

Anticon SB has centre bonded foil lap to protect purlins from condensation

## Key Design Elements



Purlin Keyway - simple roofing screw assembly

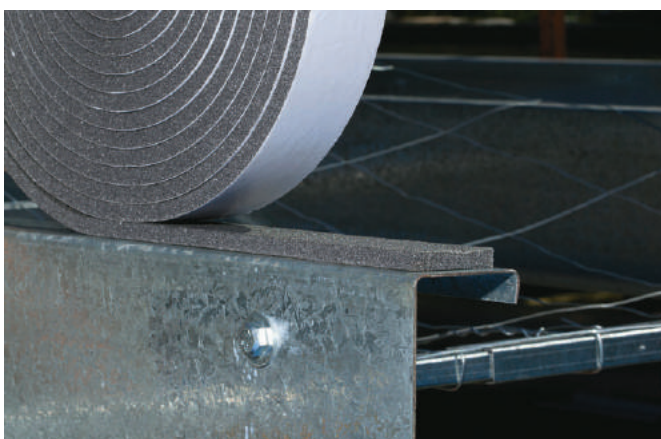

R0.2 Thermal Break Tape - 10mm thick

Table 4. Purlin and Bridge Bar Spacing

Standard Purlin Spacing	610mm, 910mm, 1210mm, 1360mm
Bridge Bar Spacing	Maximum 1500mm



Bridge Bar Stabiliser - prevents purlin 'roll'

## Designing for Green Star and Building Code Compliance

Minimum energy efficiency standards for commercial buildings are mandatory in the Building Code of Australia (BCA) and National Construction Code of Australia (NCC). Thermal insulation plays a key role in meeting these requirements and improvements in insulation also contribute to reductions in energy use which is a critical factor in Green Star accreditation. Choosing the right insulation also offers the additional benefits to the occupants of condensation control, dampening noise and controlling heat flow in and out of the building.

To achieve the BCA/NCC Section J thermal insulation values, the roof system must allow sufficient space under the roof sheet for the insulation to recover to its design thickness to provide its rated insulation value. Failure to provide enough space will result in compression of the insulation and reduce its performance.

Safebridge® essentially uses the depth of the purlins to provide a cavity for the insulation to recover to its design thickness, rather than create a space above the purlin using a roof spacer. Through the development of a patented bridging system and keyway, Safebridge® allows the purlin bridging to be set at a predetermined height during the design phase.

## Designing for Worker Safety

A unique feature of the system is the application of the safety mesh between, rather than over the top of the purlins. This configuration eliminates the need to 'lap' safety mesh and cover the purlins, resulting in immediate wire mesh material cost savings. Additionally, this method of assembly allows the use of the Safebridge® Wire Pulley system which not only saves time in applying the wire mesh, but also removes workers from the exposed edge of the roof during construction, greatly increasing their safety.

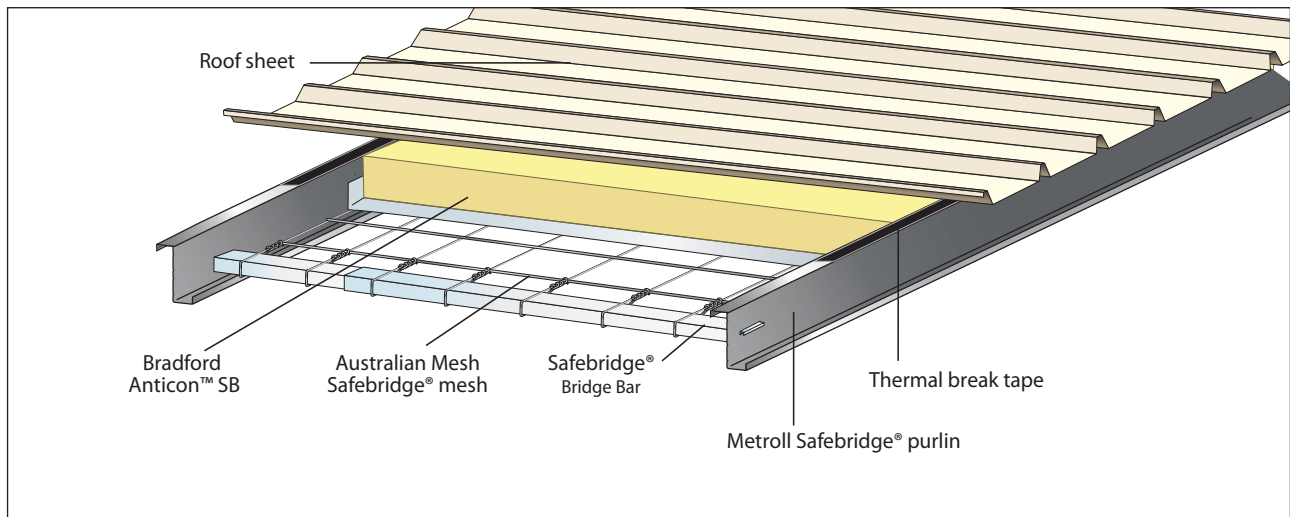

Figure 1.

## Design Considerations

As the Safebridge® system is integrated into the purlin and bridge bar assembly, there is little or no change to the roof design. Specified designs primarily need to consider the Safebridge® purlin spacing and bridge bar location relative to other roofing components during the design phase. In summary, Safebridge®:

- Can achieve high thermal performance in any climate zone (as defined by the BCA/NCC)
- Requires no additional roof spacers to elevate the roof sheet above the purlin
- Retains the structural integrity and load points of the roof interior
- Suits most roof pitches and complex roof designs

- Is available with either foil, decorative or acoustic finishes on the internal faced insulation material
- Can be used in cyclonic regions in conjunction with cyclonic rated components.

**Important:** Safebridge® relies upon specific purlin spacing listed in Table 4 on page 2. Please ensure that you consult with Bradford and Metroll early in the design phase to understand the relationship of purlin depth and spacing to R-Value and the BMT relative to your ultimate roof design loads.

# Thermal Design Tables - Performance Solutions for All Applications

The flexibility of the Safebridge® system allows a variety of different thermal solutions to be achieved by changing the combination of purlin depth and insulation products. Whilst these combinations are infinite, the two series below and on the next page provide a range of solutions for most applications, ranging from simple code compliance through to high R-Value solutions. If the right solution for your project is not listed, contact Bradford for project specific design support.

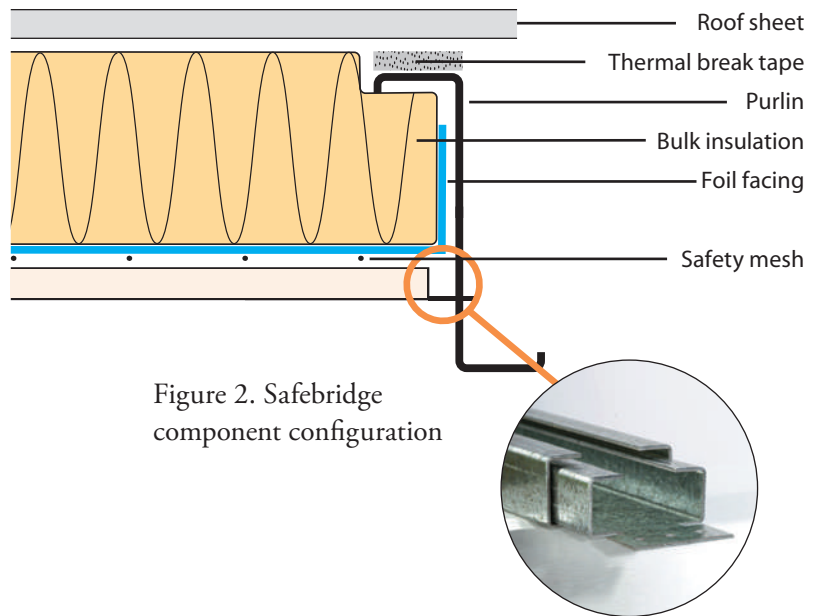

Figure 2. Safebridge component configuration

## BCA/NCC Compliant Series - Deemed to Satisfy Solutions

The BCA/NCC represents the minimum level of insulation for good energy efficiency and performance of the building envelope. Given the relatively low capital cost of insulation increasing roofing insulation R-Values during the design phase can decrease the air conditioning load, thus reducing project capital equipment costs as well as future running costs. Table 1 below outlines the minimum Safebridge system insulation requirements to meet the Deemed to Satisfy provisions of the BCA/NCC.

The BCA/NCC also sets out a requirement for adjustment of minimum R-Value to compensate for loss of ceiling insulation. Please note the following tables do not address solutions where the loss of ceiling insulation exceeds the amount nominated in BCA/NCC table J1.3b. Please refer to the BCA/NCC for further details and contact Bradford for solutions.

Table 1. BCA/NCC COMPLIANT SERIES							
Roof Systems				Metal roof with no ceiling - R0900 (reflective)	Metal roof with no ceiling - R0900 (non-reflective)	Metal roof with suspended ceiling - R1000 (100-600mm cavity)	Metal roof with suspended ceiling - R1000 (> 600mm cavity)
System Illustrations							
Climate Zone	Heat Direction	Solar Absorbance <sup>f</sup>	Required Total R-Value [R <sub>t</sub> ]	BCA/NCC Compliant Insulation Product Note: Thinner blanket must be on top for dual blanket applications			
Zone 1,2,3	Inwards	Very Light	R3.2	Anticon SB110 R <sub>M</sub> 2.5	Anticon SB140 R <sub>M</sub> 3.3	Anticon SB75 R <sub>M</sub> 1.8	Anticon SB95 R <sub>M</sub> 2.3
		Light	R3.7	Anticon SB130 R <sub>M</sub> 3.0	Anticon SB110 + SB55 R <sub>M</sub> 3.8	Anticon SB75 R <sub>M</sub> 1.8	Anticon SB110 R <sub>M</sub> 2.5
		Dark	R4.2	Anticon SB145 R <sub>M</sub> 3.6	Anticon SB130 + SB55 R <sub>M</sub> 4.3	Anticon SB95 R <sub>M</sub> 2.3	Anticon SB130 R <sub>M</sub> 3.0
Zone 4,5,6	Inwards	All	R3.2	Anticon SB110 R <sub>M</sub> 2.5	Anticon SB140 R <sub>M</sub> 3.3	Anticon SB75 R <sub>M</sub> 1.8	Anticon SB95 R <sub>M</sub> 2.3
Zone 7	Outwards	All	R3.7	Anticon SB140 R <sub>M</sub> 3.3	Anticon SB145 R <sub>M</sub> 3.6	Anticon SB125 R <sub>M</sub> 2.8	Anticon SB130 R <sub>M</sub> 3.0
Zone 8**	Outwards	All	R4.8	Anticon SB130 + SB55 R <sub>M</sub> 4.3	Anticon SB140 + SB55 R <sub>M</sub> 4.6	Anticon SB110 + SB55 R <sub>M</sub> 3.8	Anticon SB110 + SB55 R <sub>M</sub> 3.8

## Ultimate Performance Series – R-Value by Purlin Size

For applications that require R-Values beyond code compliance or simply the flexibility to achieve an R-Value for a non code compliant application, Table 2 below highlights the maximum thermal performance that can be achieved for each Metroll purlin height. By selecting the required R-Value and purlin depth, the base material thickness (BMT) and purlin spacing can then be customised based upon the projects structural requirements. Impressive thermal insulation R-Values up to Rm5.5 (inwards for a roof with no ceiling) can be achieved with the Bradford Anticon SB insulation which has been specifically developed to complement the SafeBridge system.

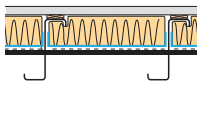
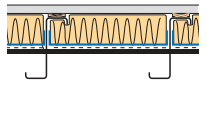
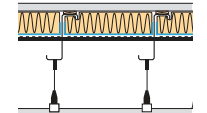
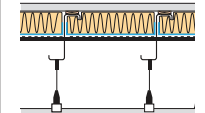
Table 2. ULTIMATE PERFORMANCE SERIES							
Roof Systems				Metal roof with no ceiling - R0900 (reflective)	Metal roof with no ceiling - R0900 (non-reflective)	Metal roof with suspended ceiling - R1000 (100-600mm cavity)	Metal roof with suspended ceiling - R1000 (> 600mm cavity)
System Illustrations							
Metroll Purlin Size	Bradford Insulation	Material R-Value [R <sub>m</sub> ]	Heat Direction	Maximum Total R-Value [R <sub>p</sub> ] Note: Thinner blanket must be on top for dual blanket applications			
150mm	Anticon SB110	R2.5	Inwards	R3.2	R2.6	R4.4	R3.7
			Outwards	R2.9	R2.8	R3.4	R3.4
200mm	Anticon SB145	R3.6	Inwards	R4.2	R3.6	R5.4	R4.7
			Outwards	R4.1	R3.9	R4.6	R4.6
250mm	Anticon SB110 + SB75	R4.2	Inwards	R4.8	R4.2	R6.0	R5.3
			Outwards	R4.7	R4.6	R5.2	R5.2
300mm	Anticon SB110 + SB110	R5.0	Inwards	R5.5	R4.8	R6.7	R5.9
			Outwards	R5.4	R5.3	R5.9	R5.9

\*Refer to the ICANZ handbook for detailed descriptions of roof constructions and thermal calculation parameters. Note that quoted R-Values are based on reflective Thermofoil facings and are not applicable to decorative facings unless stated—please contact Bradford for assistance when calculating R-Values for these materials.

\*\*Excludes high humidity applications (eg. swimming pools) - please consult Bradford.

\*Refer to the relevant BCA/NCC Solar Absorbance table for the buildings roof colour.

## System Compliance – Advanced Testing Program

Safebridge® is an innovative roofing system that has undergone hundreds of hours of development and testing to ensure it performs in accordance to its published specifications and the building code. As part of this program, the Safebridge® system has undergone experimental temperature analysis using a roof section to validate 3 dimensional theoretical modelling of heat transfer calculations. This complex process was used to develop the new generation of Bradford Anticon SB thermal insulation used in the Safebridge® system to ensure effective management of condensation across all climate zones through the purlin and adjacent materials (roof sheet, mesh, screw, insulation and thermal break tape). Modification of this system by the substitution of similar or alternative products cannot be guaranteed to perform in accordance with the stated information provided in this and other documentation. Please note that the design of high humidity applications (such as indoor swimming pools) should always be reviewed with Bradford during the design phase.

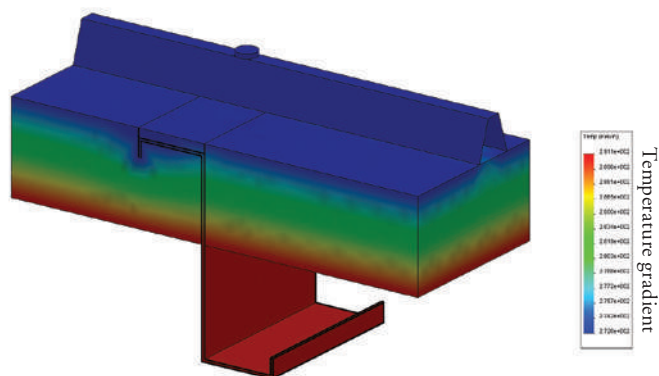

Figure 3. Complex Thermal Modeling of Temperature Analysis Across Roof Structure

## Specifying SafeBridge®

When specifying SafeBridge, the following components have been tested and recommended to achieve the performance standards specified in this document:

- Metroll SafeBridge® Purlins and Bridge Bars
- Bradford SafeBridge® Anticon SB[size] RM[value] centrally faced with Bradford Thermofoil Medium Duty [plus optional additional specification - laid on top of Bradford Thermoplast 993 White - laid separately]
- Bradford Thermal Break Tape 10mm
- Australian Mesh SB[width] SafeBridge® Safety Mesh supplied by Bradford Insulation (installed between the purlins)
- ITW Buildex Metal Tech Screws
- Metal roof sheet to suit

## Useful Reference Documents

Safebridge® Installation Guides

Safebridge® Work Method Statement



For further details and technical enquiries

call **1300 887 160** or email **[bradfordinsulation@csr.com.au](mailto:bradfordinsulation@csr.com.au)**

**Bradford™**  
for smarter environments

### Bradford Insulation

55 Stennett Rd, Ingleburn NSW 2565 Australia  
[www.bradfordinsulation.com.au](http://www.bradfordinsulation.com.au)

Bradford Insulation is a business division of CSR Building Products Limited ABN 55 008 631 356

The contents of this brochure are copyright protected and may not be reproduced in any form without prior written consent of Bradford Insulation. Recommendations and advice regarding the use of the products described in this brochure are to be taken as a guide only, and are given without liability on the part of the company or its employees. We reserve the right to change product specifications without prior notification, please refer to the Bradford website for the latest version of this document. The purchaser should independently determine the suitability of the product for the intended use and applications