



Metroll[®]

BETTER SERVICE • BETTER BUILDING SOLUTIONS

METAL DOOR FRAMES & METER BOXES

**METROLL
WA
ONLY**



APRIL 2026

DOOR FRAME BASICS

DETERMINING LEFT OR RIGHT HAND DOORS

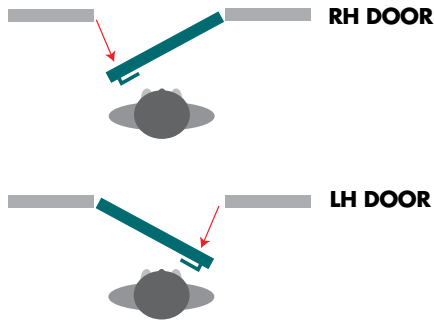

HINGE TYPES

- **FIXED PIN** For outward opening garage doors.
- **BROAD BUTT 100 x 100mm** For Deluxe Doors requiring opening to 180 degrees. NOTE: The door handle may prevent a full 180 degree.
- **LIFT OFF (WC)** Lift off hinges are fitted to all WC Frames.

STRIKER PLATE HEIGHT

Standard height to centre from floor level 1000mm on all frames. Variations available.

METROLL TOLERANCES ± 2.0 mm

INSTALLATION GUIDELINES

- All frames to be installed with temporary bottom spreader bar in place, or a fixed bottom rail where required.
- Frames to be checked for plumb when installing.
- Ensure all frames are in good condition and correct handing before installing.
- Ensure Hinge Leafs are kept together.
- Ensure frames are correct and to specification prior to installing.
- Contact Metroll for assistance prior to installation if any issues are encountered.

INSTALLATION IN CAVITY WALLS USING OFFSET BRICK TIES

Standard frames (95mm back opening) may be installed in double brick cavity walls. The frame must be positioned in the middle of the wall covering the cavity.

SECTION THROUGH CAVITY

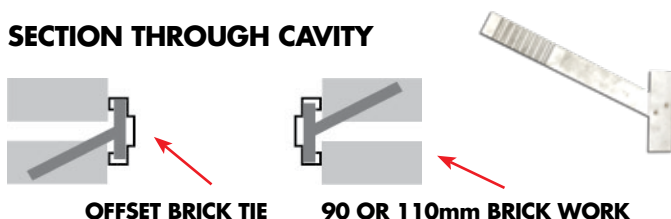

METROLL RESIDENTIAL DOOR FRAMES

BRICK TIES SUPPLIED

To ensure a tight, permanent fit, each frame is supplied with easy to install 4mm brick wire ties.

TWO BACK OPENINGS

Supplied in 95mm or 114mm back openings to suit standard bricks.

CUSTOM HEIGHTS/WIDTHS

Available with additional lead time.

FULL HEIGHT FRAMES

Frames to suit 2300mm and 2340mm high doors available on request.

WC FRAMES

Supplied with lift-off hinges and 25mm false head.

MULTI-DOOR COMBOS

2, 3, 4, 5 and 5 door combos available.

AVAILABLE ACCESSORIES

- Pull Through White Rubber Buffers.
- Extra 100 x 75 x 1.6mm Fitted Hinge
- Corrugated, Offset Brick Ties
- Striker Kits
- Stud Framing Clips
- Steel Stud Frame Brackets
- Screw Fix Hinge Preparation
- Fixed Pin Hinge 100 x 75 x 1.6mm
- Broad Butt Hinge 100 x 100mm
- Shelf Rail
- Mullion
- Sill / Bottom Rail
- Dead Lock Striker Cut Out

ORDERING CHECKLIST

- Always nominate left hand or right hand opening.
- Specify the door size.
- Specify the back opening, 95mm or 114mm.
- Specify fixed bottom rail, shelf rail or deadlocks.
- Profile dimensions cannot be altered.
- Maximum door thickness is 38mm.

Metroll's standard Terms & Conditions of Sale apply. Visit metroll.com.au for a copy.

METROLL RESIDENTIAL DOOR FRAME FEATURES

1 PRECISION MITRES

Absolute precision is our trademark. Each corner has been pre-cut with a 45° mitre giving a snug, accurate fit.

2 UNOBTRUSIVE HINGES

Slimline, 100 x 75 loose-pin zinc coated hinges are welded to all Metroll Frames allowing for quick and easy door installation.

3 BUILT-IN ARCHITRAVES

Available in several styles enhancing overall appearance and ensuring a precise fit.

4 LOCK 1035mm HIGH FROM FLOOR LEVEL

Stainless steel striker plate with a leading edge that complements the clean lines of Metroll frames.

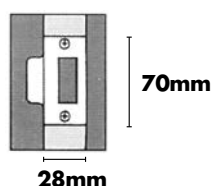

5 SHOCK ABSORBING RUBBER BUFFERS

Rubber buffers are incorporated into all Metroll Door Frames reducing noise and vibration.

6 TEMPORARY BOTTOM RAIL

Metroll Residential Door Frames are supplied with temporary bottom rails to ensure stability during transportation and installation. Designed for easy removal.

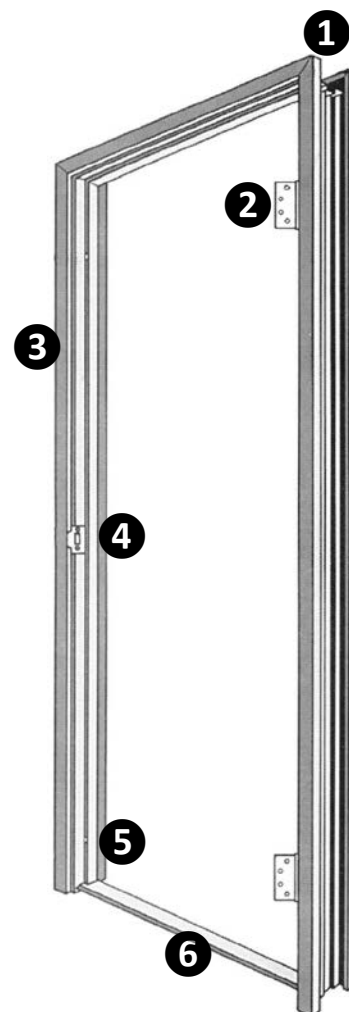

METROLL RESIDENTIAL RANGE SPECIFICATIONS

| SINGLE | DOUBLE | WC | SINGLE SLIDER | DOUBLE SLIDER |
|------------|----------------|------------|---------------------|---------------------------|
| 2040 x 410 | 2040 x 2 x 410 | | | 2040 x (2 x 545 [DS570]) |
| 2040 x 520 | 2040 x 2 x 520 | | | 2040 x (2 x 645 [DS 670]) |
| 2040 x 620 | 2040 x 2 x 620 | | | 2040 x 620 |
| 2040 x 720 | 2040 x 2 x 720 | 2040 x 720 | 2040 x 720 (DS 770) | 2040 x (2 x 795 [DS 820]) |
| 2040 x 770 | 2040 x 2 x 770 | 2040 x 770 | 2040 x 770 (DS 820) | 2040 x (2 x 845 [DS 870]) |
| 2040 x 820 | 2040 x 2 x 820 | 2040 x 820 | 2040 x 820 (DS 870) | 2040 x (2 x 895 [DS 920]) |
| 2040 x 870 | 2040 x 2 x 870 | 2040 x 870 | 2040 x 870 (DS 920) | 2040 x (2 x 945 [DS 970]) |
| 2040 x 920 | 2040 x 2 x 920 | 2040 x 920 | 2040 x 920 (DS 970) | |

METRO DOOR FRAME

- Contemporary Styling
- Sharp, Square Edges



SPECIFICATIONS

STOCKED 95mm BACK OPENING

All other sizes available with lead time

| SINGLE 2 HINGE | SINGLE 3 HINGE | SINGLE 3 HINGE & DEADLOCK | DOUBLE 2 HINGE* | WC 2 HINGE | SINGLE SLIDER | DOUBLE SLIDER |
|----------------|----------------|---------------------------|------------------|------------|---------------------|---------------------------|
| 2040 x 410 | 2040 x 820 | 2040 x 820 | 2040 x (2 x 410) | 2040 x 620 | 2040 x 620 (DS 670) | 2040 x (2 x 545 [DS 570]) |
| 2040 x 520 | 2040 x 920 | | 2040 x (2 x 520) | 2040 x 720 | 2040 x 720 (DS 770) | 2040 x (2 x 645 [DS 670]) |
| 2040 x 620 | | | 2040 x (2 x 620) | 2040 x 820 | 2040 x 770 (DS 820) | 2040 x (2 x 745 [DS 770]) |
| 2040 x 720 | | | 2040 x (2 x 720) | 2040 x 920 | 2040 x 820 (DS 870) | 2040 x (2 x 845 [DS 870]) |
| 2040 x 820 | | | 2040 x (2 x 820) | | 2040 x 920 (DS 970) | |
| 2040 x 870 | | | | | | |

*2 hinges each side

STOCKED 114mm BACK OPENING

All other sizes available with lead time.

| SINGLE 2 HINGE | SINGLE 3 HINGE | SINGLE 3 HINGE & DEADLOCK | DOUBLE 2 HINGE* | WC 2 HINGE |
|----------------|----------------|---------------------------|------------------|------------|
| 2040 x 520 | 2040 x 820 | 2040 x 820 | 2040 x (2 x 520) | 2040 x 620 |
| 2040 x 620 | 2040 x 870 | | 2040 x (2 x 620) | 2040 x 720 |
| 2040 x 720 | 2040 x 920 | | 2040 x (2 x 720) | 2040 x 820 |
| 2040 x 820 | | | 2040 x (2 x 820) | |
| 2040 x 870 | | | | |

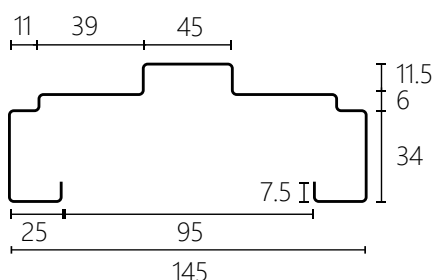
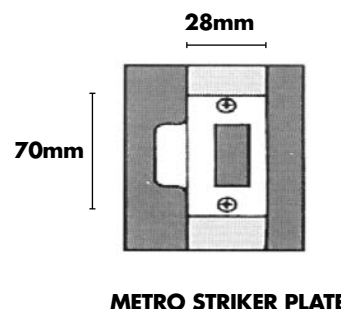

95mm BACK OPENING

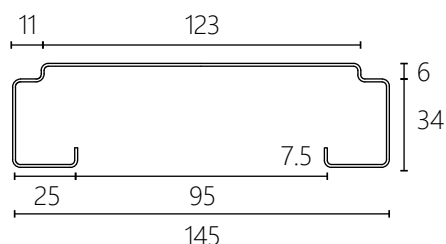

SLIDER 95mm BACK OPENING

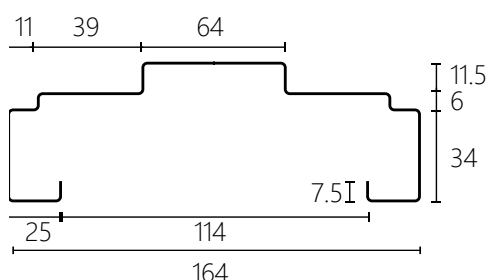

114mm BACK OPENING

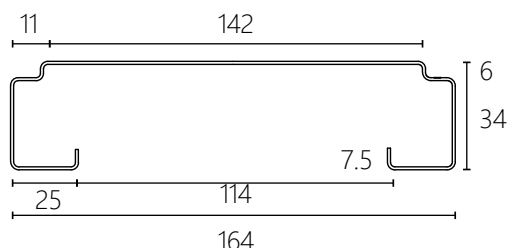

SLIDER 114mm BACK OPENING

METRO ROBE DOOR FRAME

- Available in 2, 3, 4, 5 and 6 door combinations.
- A shelf rail is an optional extra. It is welded into position approx. 1700mm from floor level.
- Special sizes are available on request.
- Frames are ordered by door size and Metroll supply a frame 3mm wider for each door leaf.
- With 3 or 5 door frames please nominate which side the single door is on.
- The single door is always hung on the stile unless otherwise requested.

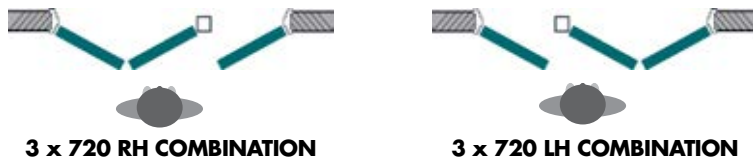
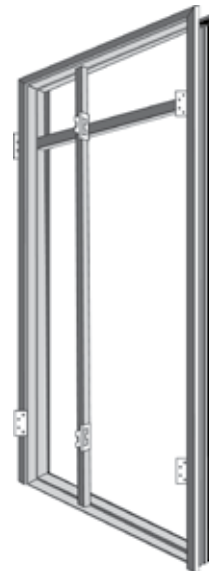

SPLIT DOOR FRAME

- Quick and easy installation
- Ideal for various wall thicknesses

A Split profile is made in two halves and fitted from each side of the opening. It is of welded construction with counter-sunk holes for fixing and removable spreader bars to each half of the frame. Suitable for stud work applications.

- Split Door Frames are compatible with most hardware types.
- Custom sizes available with additional lead time.



SPECIFICATIONS

| DOOR SIZE | STUD WALL OPENING SIZE | STUD OPENING SIZE |
|----------------|------------------------|--------------------------|
| 2040 x 920 | 2080 x 855 | Door Height: Add 40mm |
| 2040 x 820 | 2080 x 855 | |
| 2040 x 720 | 2080 x 755 | |
| 2040 x 620 | 2080 x 655 | Door Width: Add 35mm |
| 2040 x 2 x 620 | 2080 x 1275 | |
| 2040 x 2 x 820 | 2080 x 1675 | |

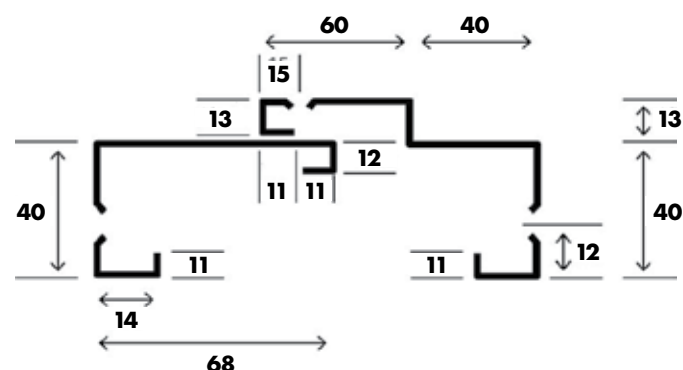

FEATURES

- Shock absorbing rubber buffers
- Built in architrave
- Precision mitres
- Unobtrusive hinges
- Stainless steel striker plate
- Suitable for thicknesses 85 - 120mm

RECOMMENDED FIXING

1. Insert both frame halves into finished stud wall opening.
2. Clamp both halves securely against wall, clamping over extreme edges of architrave face.
3. Drill inner frame through countersunk holes in door stop using a 3mm (1/8") drill.
4. Fix both halves together using 8g x 25 counter-sunk head self-tapping screws through prepared holes in door stop, then remove clamps.
5. Ensure that the door is plumb and parallel.
6. Fix frame to stud wall through prepared holes in architrave face using appropriate countersunk head screws.
7. Fill over all screws using auto body-filler or similar and sand down to a smooth, flat finish.
8. Remove bottom spreader bars.



METROLL METER BOXES

Gas, Electric & Combination

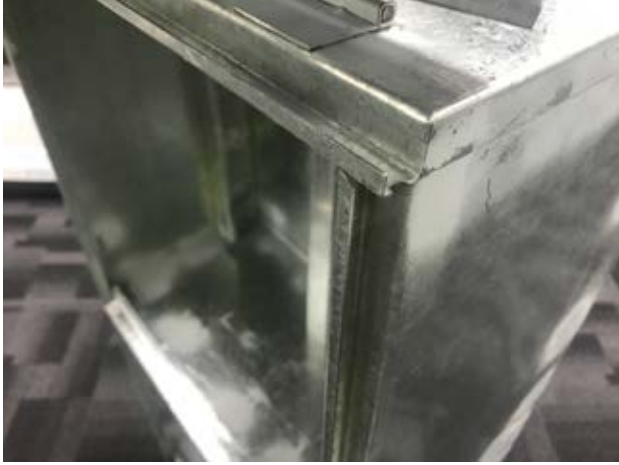

Engineered edges prevents water and objects entering.

Metroll Meter Boxes are engineered for quality, built tough and are excellent value. Manufactured from 1.00mm BMT galvanised steel. Available in combination or single sizes and with optional view panel and lock.

ATCO & WESTERN POWER COMPLIANT

Metroll Meter Boxes comply with:

- **IP24**
- **ATCO GAS**
ATCO Gas Australia Meter Boxes for AL8-18 Gas Meters.
Document Code: ENS TS001, Revision 7, 30.01.2014
- **WESTERN POWER**
Horizon Power, Western Australia Distribution Connectors Manual. Fifth Edition 2015.



**COMBINATION
METER BOX**



**DOMESTIC ELECTRIC
METER BOX**



**DOMESTIC GAS
METER BOX**

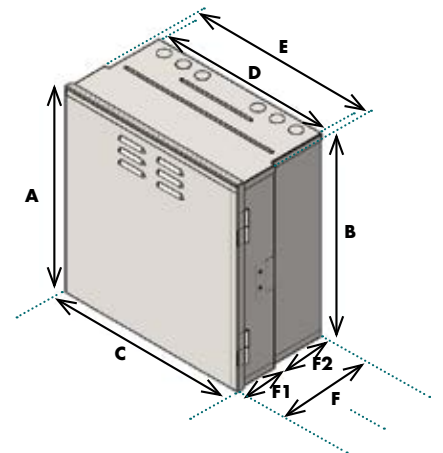

SPECIFICATIONS

| METER BOX | | mm | | | | | | | |
|-------------|----------|------|------|-----|-----|-----|-----|-----|-----|
| | | A | B | C | D | E | F | F1 | F2 |
| Gas | Plain | 514 | 505 | 497 | - | 492 | 258 | - | - |
| | Recessed | 514 | 505 | 497 | 470 | 492 | 258 | 112 | 146 |
| Electric | Plain | 509 | 505 | 497 | - | 492 | 272 | - | - |
| | Recessed | 509 | 505 | 497 | 470 | 492 | 273 | 127 | 146 |
| Combination | Plain | 1029 | 1023 | 497 | - | 492 | 272 | - | - |
| | Recessed | 1029 | 1023 | 497 | 470 | 492 | 272 | 126 | 146 |

All models available with optional view panel and lock. View panel fitted to the left hand side of meter box lid.

Can we assist with any additional Steel Building Products?

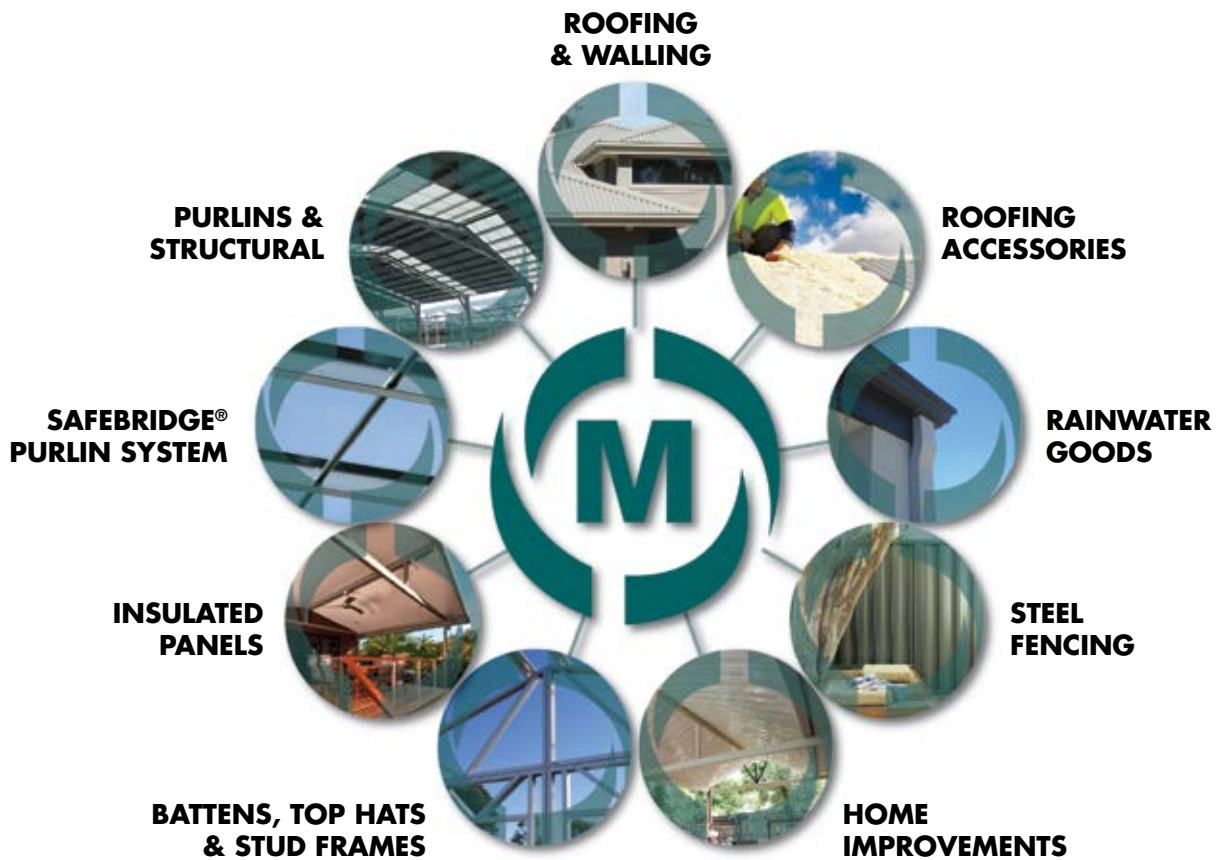

METROLL PERTH

5 Chilver Street, Kewdale, WA 6105

P: 08 9365 5444

METROLL BUNBURY

11 Proffit Street, Bunbury, WA 6230

P: 08 9796 9796

METROLL ALBANY

179 Chester Pass Road, Albany, WA 6330

P: 08 9841 6966

METROLL KALGOORLIE

45 Gt. Eastern Highway, West Kalgoorlie, WA 6430

P: 08 9024 1388



metroll.com.au